

Vaillant Storages for Renewable Systems

PREHEAT symposium, Intersolar 2007, Freiburg

June 2007

VGN-RD Max Bankowski

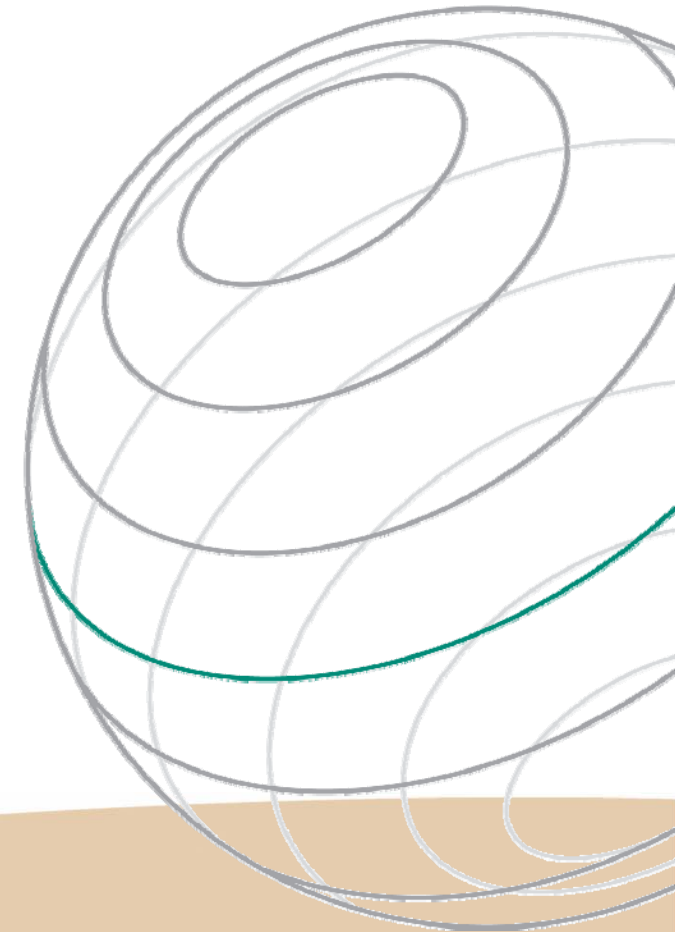

Vaillant Group – heating technology company

With 10.000 employees, sales of more than 2.4 million appliances and a turnover of 2 billion Euro is Vaillant Group a leading heating technology company in Europe.

In EUR million	2005	2006	Variation in %
Sales	1.791	1.991	11
Investment	53	64	21
Research & Development	49	56	14
Employees	8.616	10.055	17
- of which in Germany	3.617	3.652	1
- of which international	4.999	6403	28



ABRU

awb
CV-KETELS

B BONGIOANNI



 **Glow-worm**

 **Hermann**

protherm



 **Vaillant**

Vaillant Group – International presence

With 1.6 million units sold in 2006, Vaillant Group is the leading supplier of wall-hung boilers both in Europe and worldwide

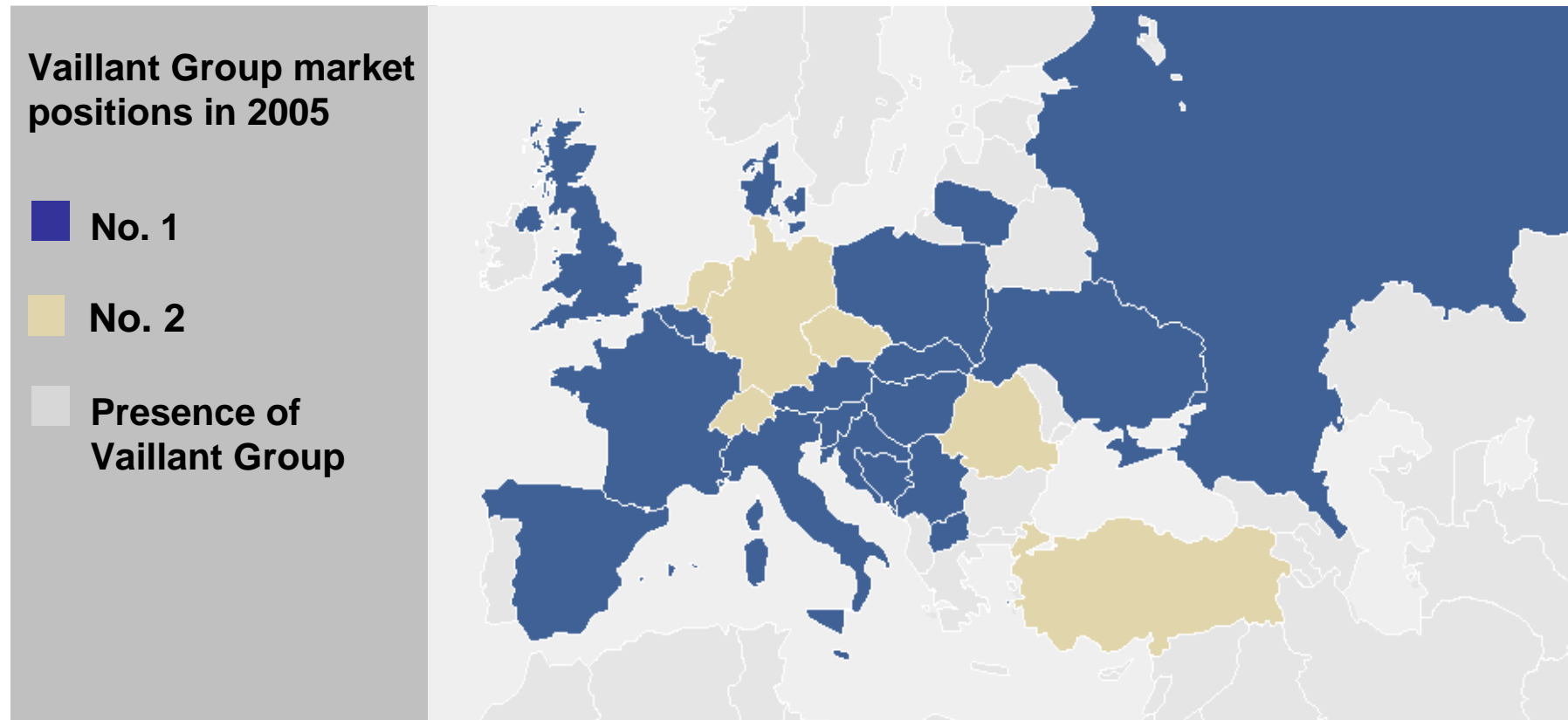

Vaillant Group – history

- ▶ **1874** Founding of Vaillant by Johann Vaillant in Remscheid (Germany)

- ▶ **1894 – 1963** New market segments created through innovations: first in 1894 with the gas water heater, then in 1961 with the gas wall-hung boiler, and in 1963 with the gas combination wall-hung boiler

- ▶ **1987 – 1997** - 1987 Hepworth plc takes over Glow-worm - 1993 Hepworth plc takes over AWB
- 1991 Hepworth plc takes over Saunier Duval - 1997 Hepworth plc takes over Protherm

- ▶ **2000** Vaillant takes over Bongioanni Pensotti Kalore (BPK)

- ▶ **2001** Vaillant GmbH acquires Hepworth plc and forms one of the world's leading heating and air-conditioning technology companies
Market launch of a new generation of wall-hung combination and condensing boilers

- ▶ **2002** New organisational structure: integration of both groups accomplished / start of field tests with fuel cell heating appliances / completely new boiler programme

- ▶ **2003** Start of development programme for group-wide product modules and components

- ▶ **2004** Acquisition of majority stake in the Italian heating technology manufacturer Hermann S.r.l.
Commissioning of new module plant in Trenčín, Slovakia

- ▶ **2005** Sale of Hepworth Building Products and complete takeover of Protherm
Market launch of a new generation of high efficiency boilers (ecoTEC plus/pro, UK and Europe)

- ▶ **2006** Start of heat pump manufacture in Gelsenkirchen

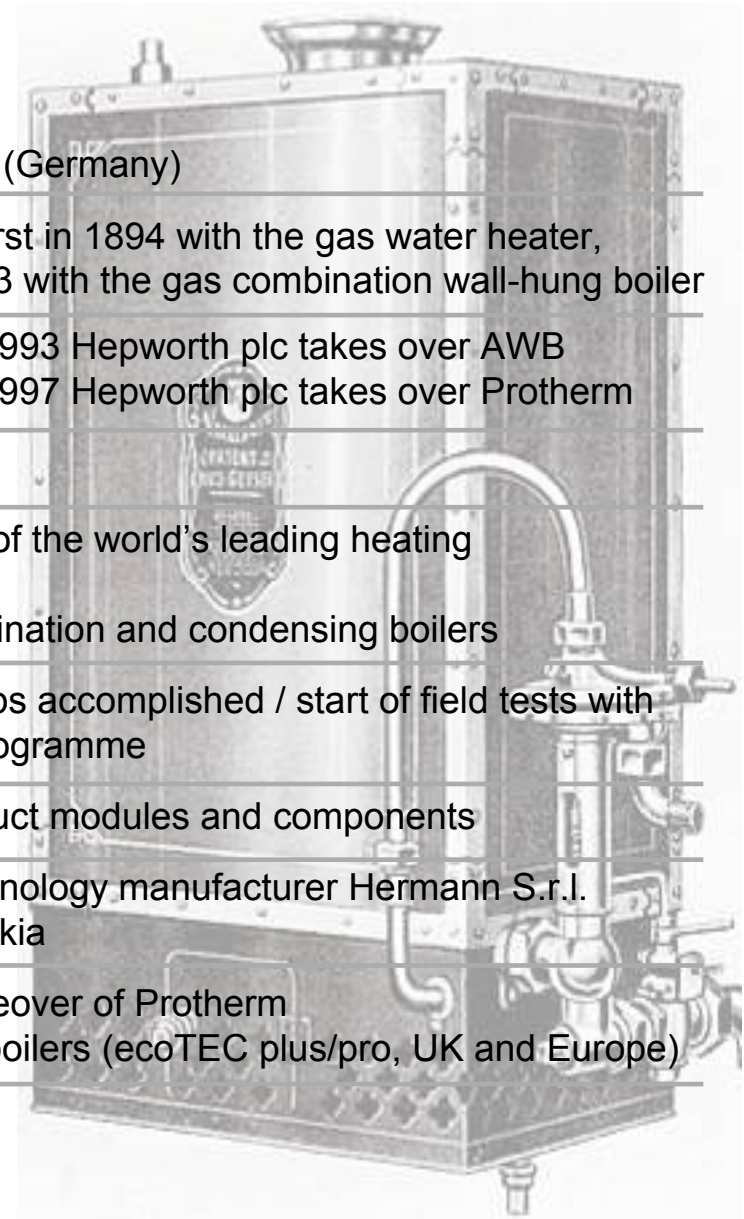

Vaillant Group – New Activities & Renewables



CHP-unit

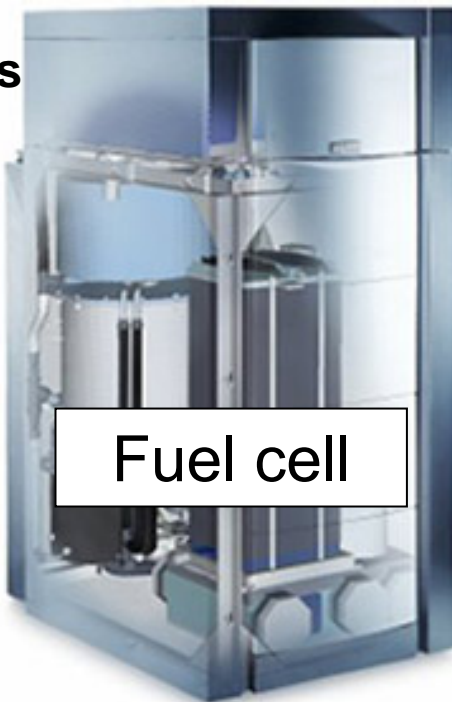

Fuel cell



Bio mass



Solar

Vaillant storages



Heat pump

Current Vaillant Storage Systems

all-purpose
storage



uniSTOR

Solar
storage



VIH S

Shift load
storage



actoSTOR

new Storage concepts

Vaillant Storage Systems – Shift load storage

New Vaillant shift load technology: ActoNomic



**ecoTEC plus
VUI xxx /
actoSTOR
VIH CL 20 S**

**aquaPLUS
VUI xxx**

**ecoCOMPACT
auroCOMPACT
atmoCOMPACT
VSC xxx**

**actoSTOR
VIH K 300**

**actoSTOR
VIH RL 300-500**

Applications in small apartments up to multi family houses

Vaillant Storage Systems – Shift load storage

The actoSTOR 300-500 enable us to offer complete systems (DHW & heating) up to 35 family houses (NL 50)

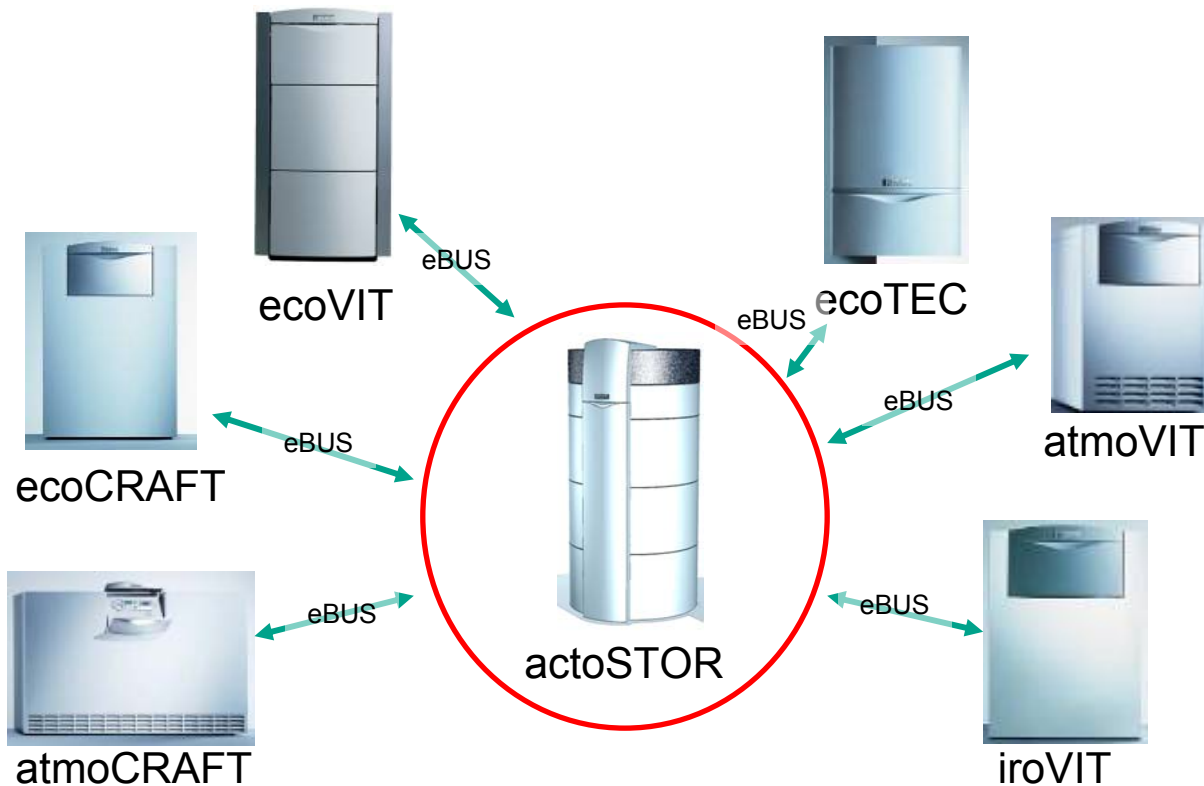

Shift load storage



new Storage concepts for more efficiency

Vaillant Storage Systems – Shift load storage

It is possible to use the actoSTOR with other systems.

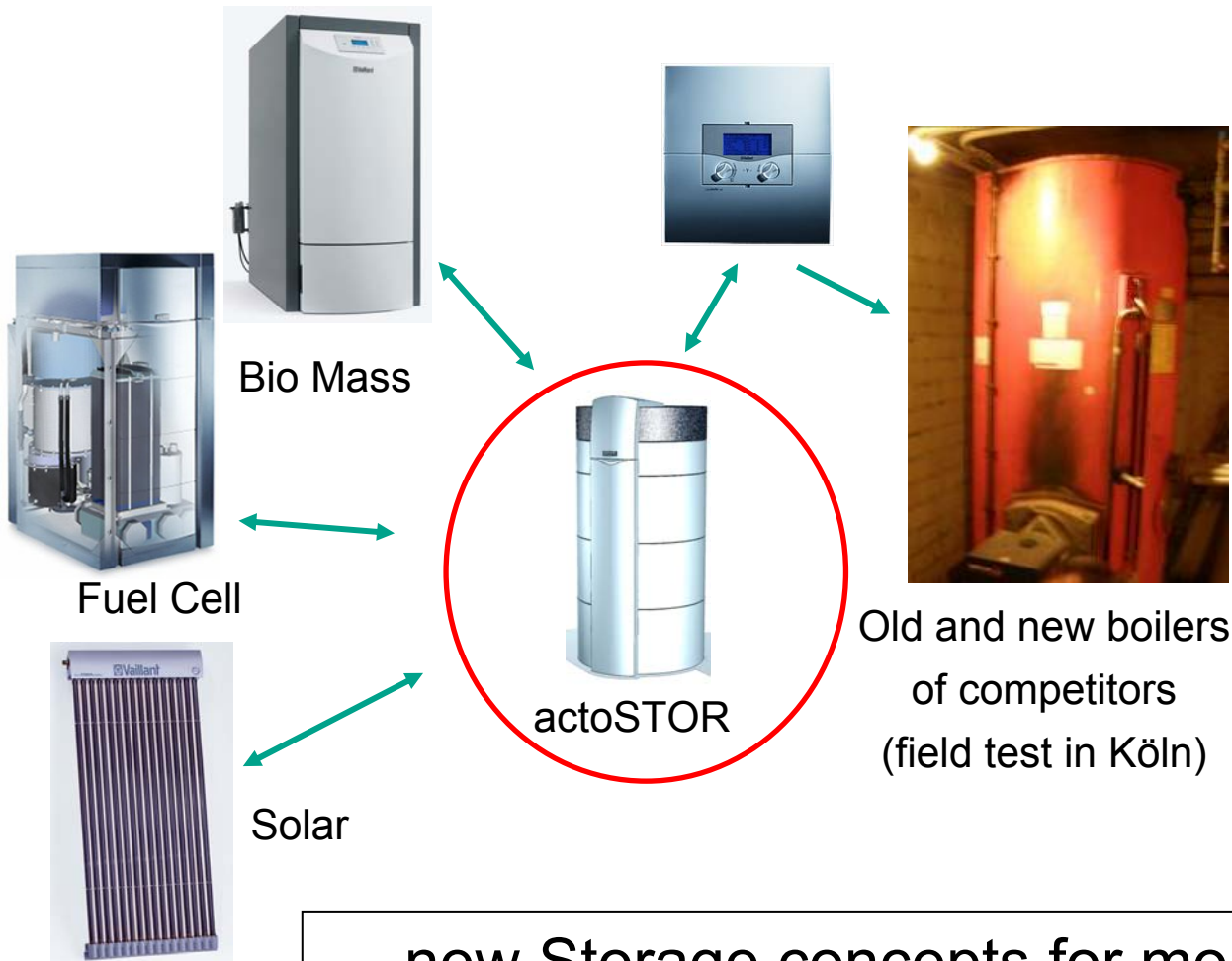

new Storage concepts for more flexibility

Vaillant Storage Systems – Shift load storage

Shift load system

VIH RL ...

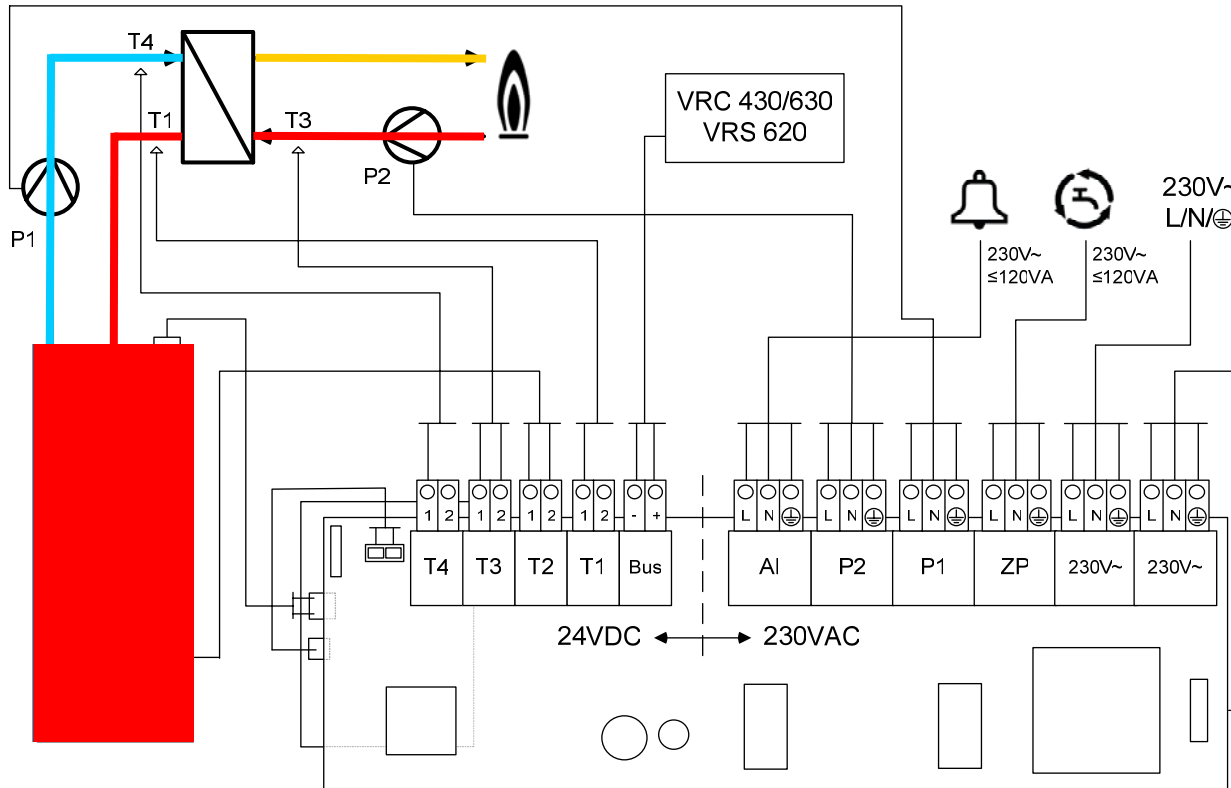

Shift load storage



new Storage concepts for more flexibility

Vaillant Storage Systems – Shift load storage

Shift load storages

Vaillant

acto STOR
VIH RL 500

Buderus

Logalux
LF 500

Viessmann

Vitocell
L100

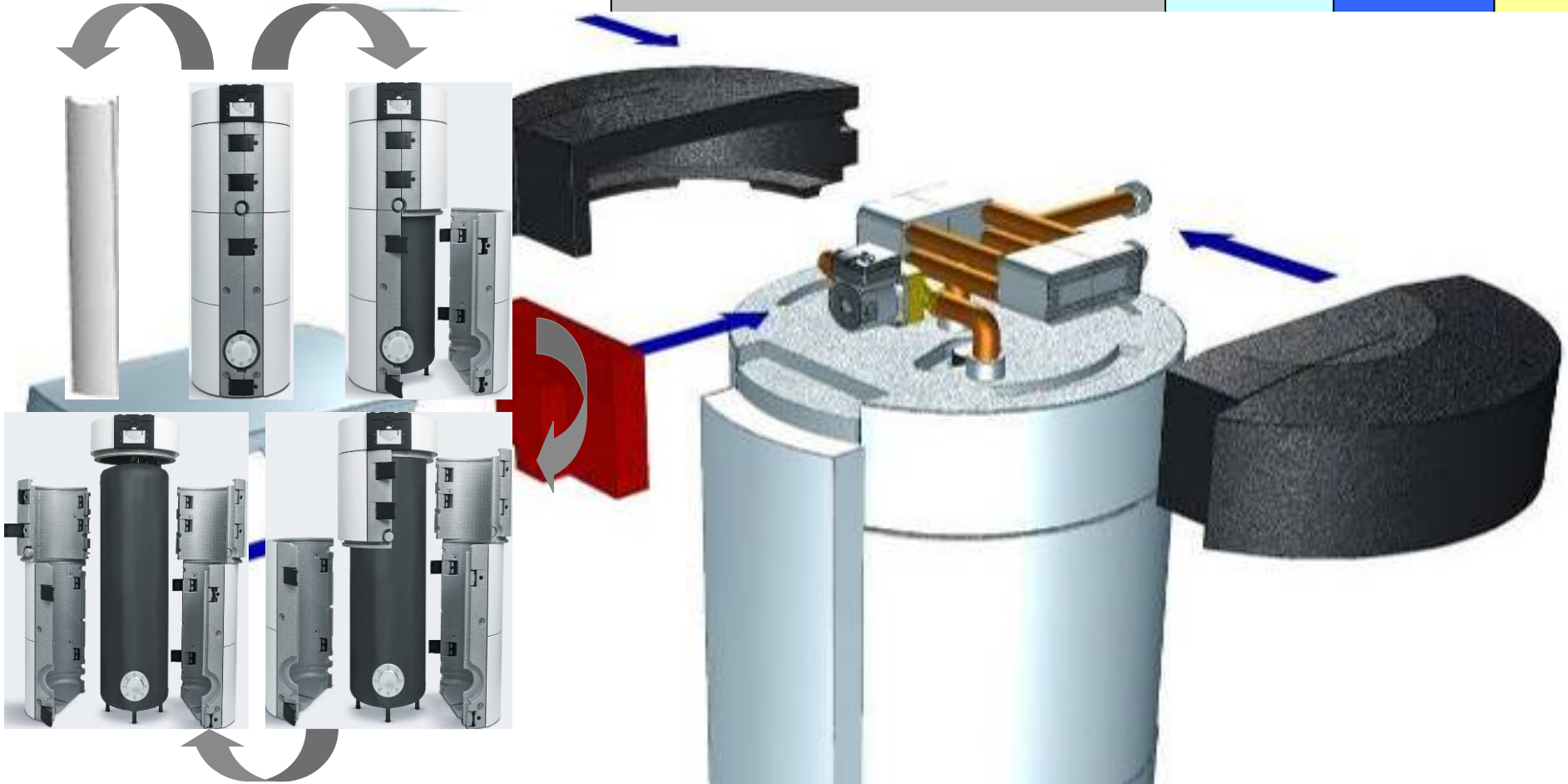

Best in class !

Vaillant Storage Systems – allSTOR: Buffer Storage

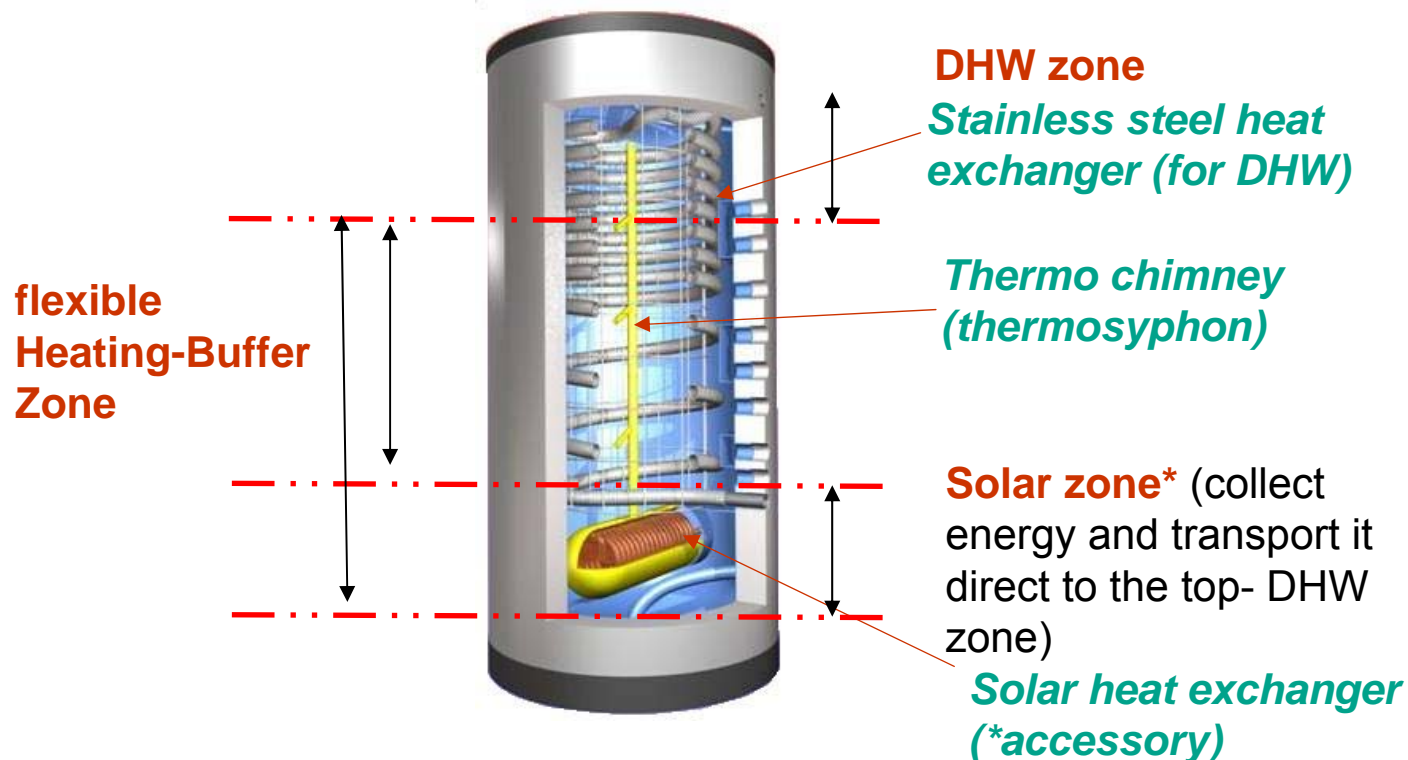

Buffer storages with integrated Fresh Water Production enable us to offer system solutions for OFH with:

- High solar efficiency (dhw and heating)
- Hygienic domestic hot water (Legionella protection / stainless steel heat exchanger)
- Flexibility of Application (heat pumps, biomass, gasboilers,...)

Vaillant Storage Systems – allSTOR: Buffer Storage

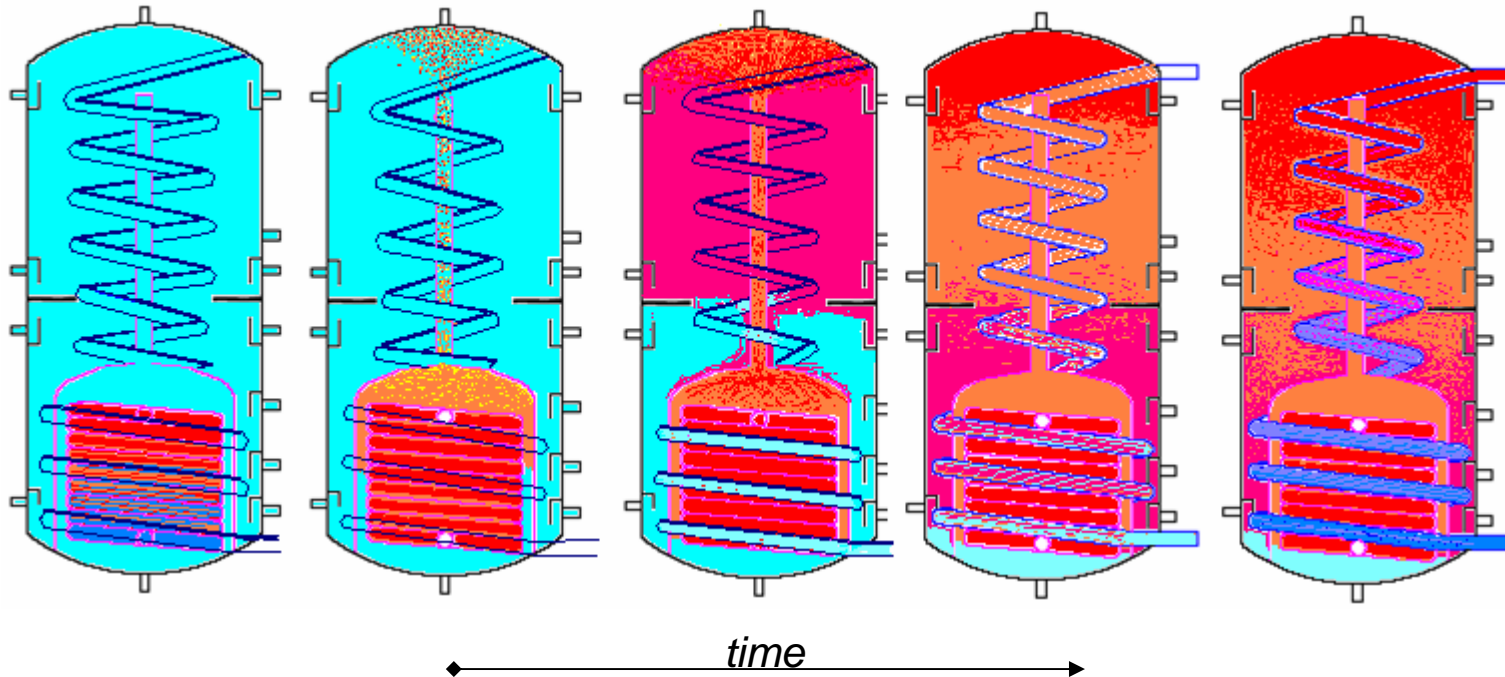

- Buffer storages with integrated thermopipe enable us to offer system solutions for OFH with:
- High solar efficiency (dhw and heating)
 - Hygienic domestic hot water (Legionella protection / stainless steel heat exchanger)
 - Flexibility of Application (heat pumps, biomass, gasboilers,...)
 - Priority of energy supply

Vaillant Storage Systems – allSTOR: Buffer Storage

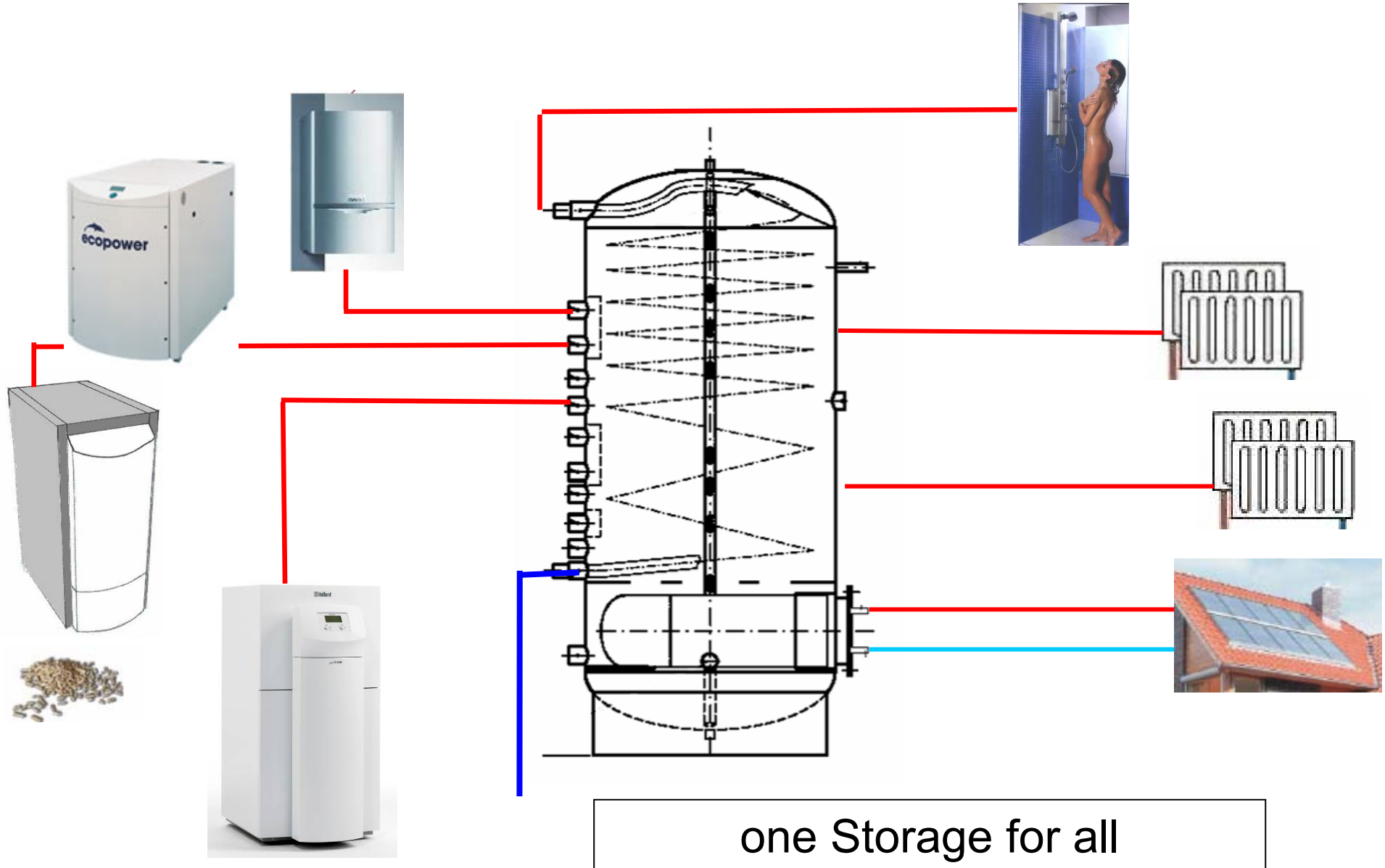

Vaillant Group – Development Activities now



CHP-unit

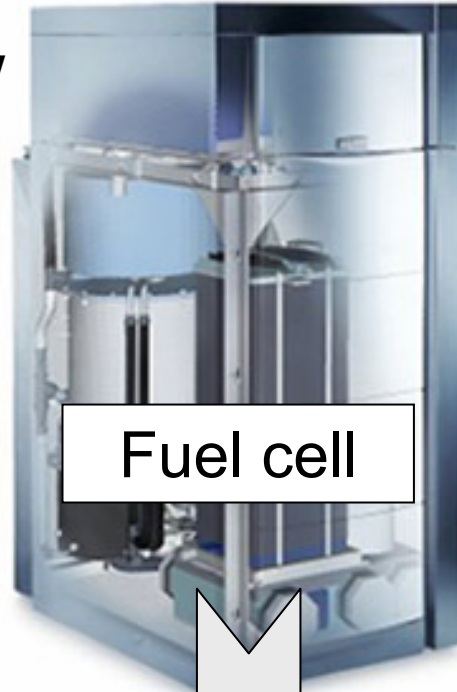

Fuel cell



Bio mass



Solar

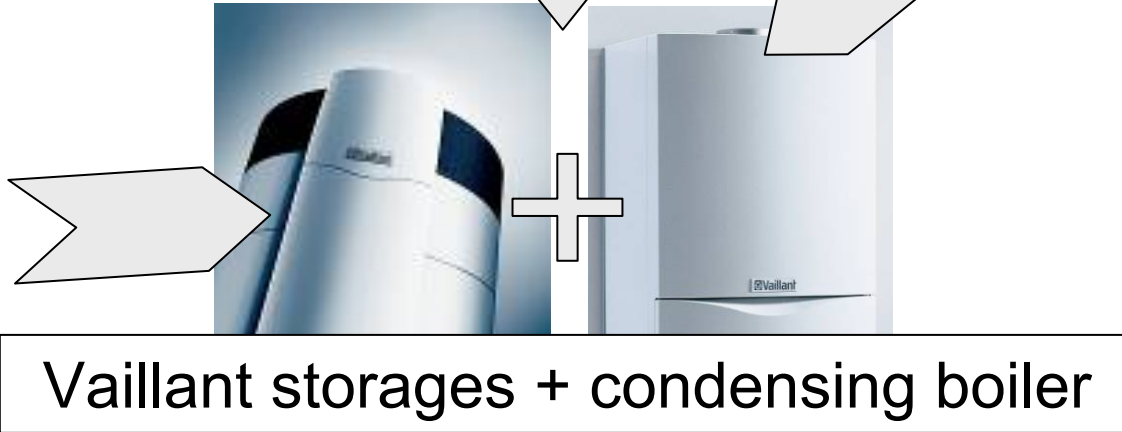

Vaillant storages + condensing boiler



Heat pump

Renewables with Vaillant for clean future

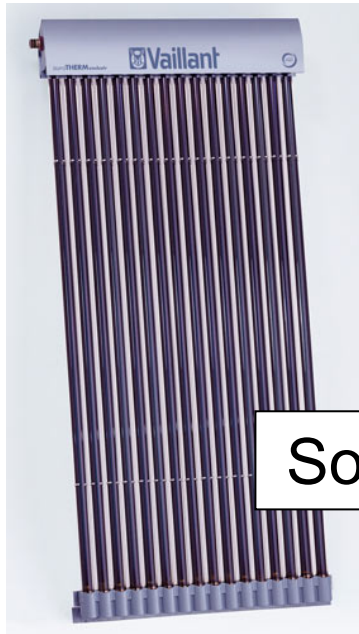

Solar

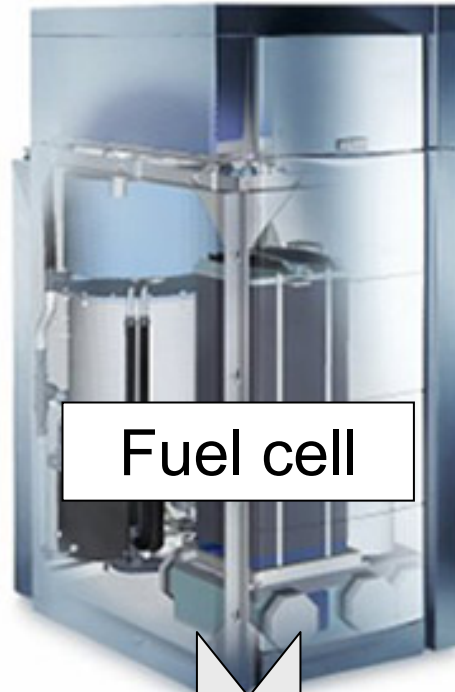

Fuel cell



Heat pump

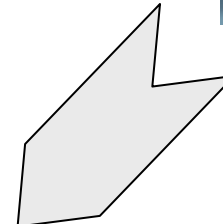
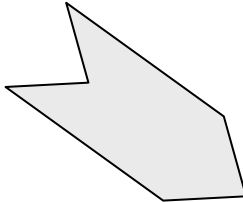

Research new Storage concepts
for clean energy

Thanks for Interest

PREHEAT symposium, Intersolar 2007, Freiburg

June 2007

VGN-RD Max Bankowski

